

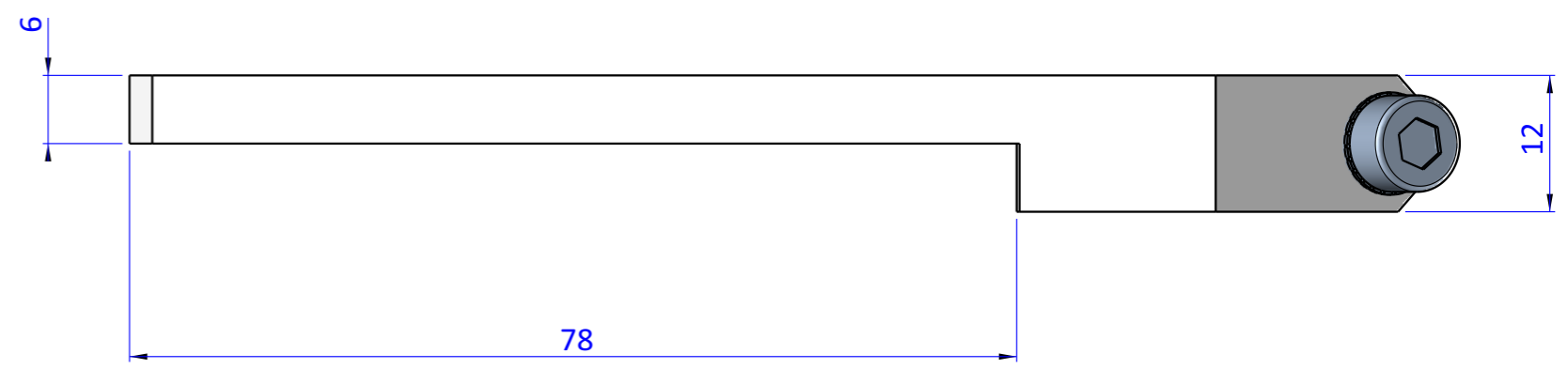

THE PROPERTY OF THE DRAWING IS ESTABLISHED BY LAW. IT IS FORBIDDEN TO PRODUCE OR SHOW IT TO THIRD PART. WITHOUT A WRITTEN AGREEMENT.

Item	Name	Q.ty
1	R.5.SCH	1
2	V.TCE5x18	1
3	WSL.2060.U	1

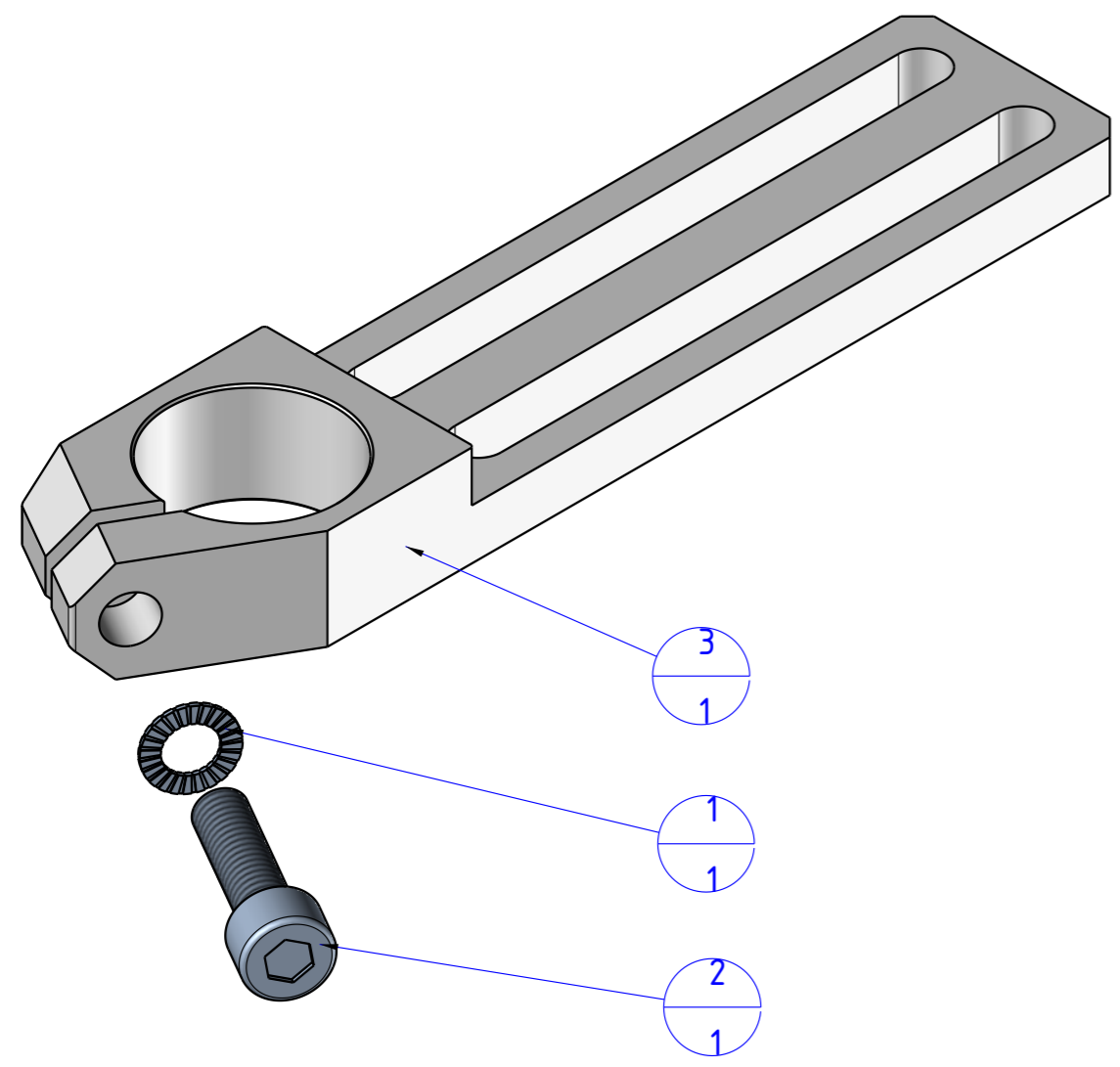
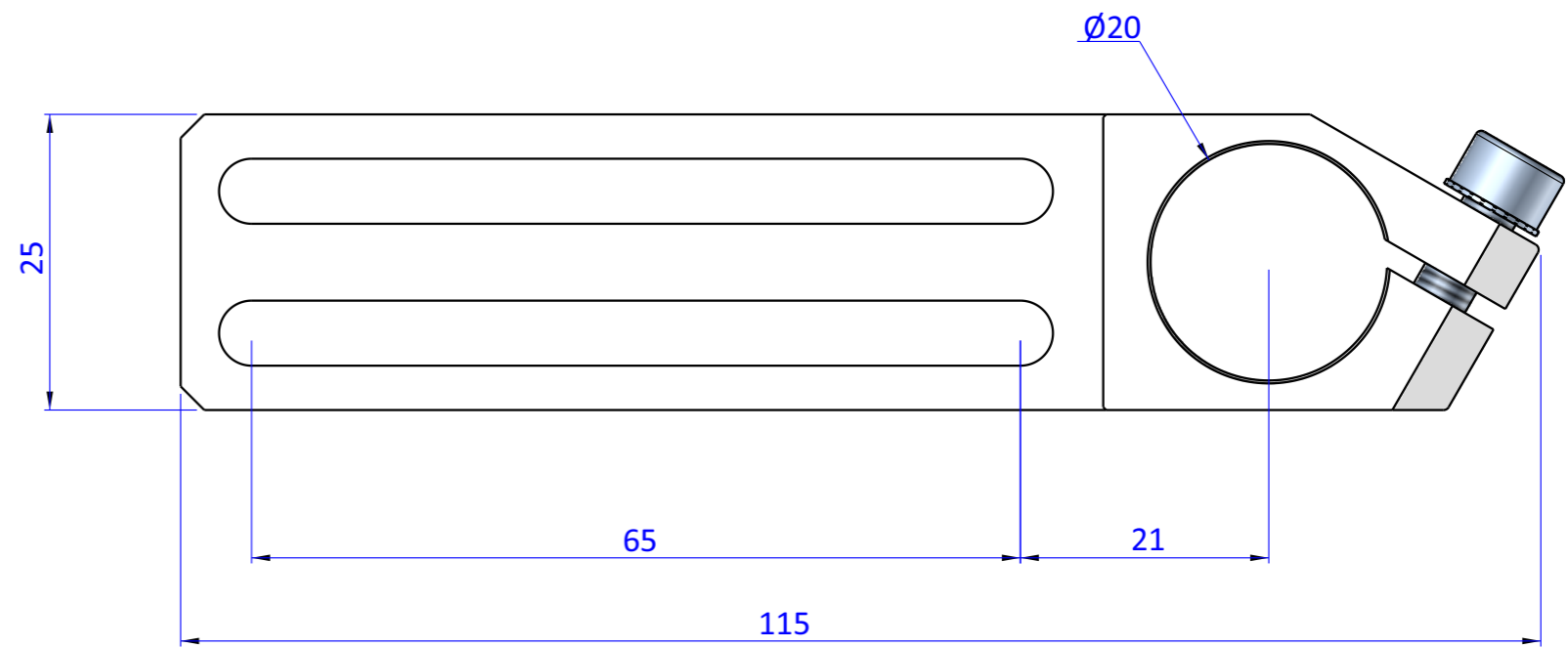

Format A3
UNI 936-76

 FPS FPSERVICES AUTOMATION		DESIGNED FROM FPS Automation		REVIEW A	
		DATE 01/03/2021	WEIGHT 0,037kg		
GENERAL TOLERANCE UNI - ISO 2768 CLASSE f	DESCRIPTION CA.WSL.2060.U		CODE CA.WSL.2060.U		